



# Signage

## Specials

Finials	Street names
Fingers	Notice boards
Columns	Hanging baskets

# Information Signs

## FINGER POSTS

The finger post is a well proven means of giving clear directions to pedestrians.

The styles available are suitable for all locations. Type 701 is fully cast, others feature a cast/steel base with a steel column.

All posts support fingers of varying sizes and a choice of finials. Power access doors and flanged bases are optional.

Within a scheme it is often desirable to make all columns the same height. To achieve this, spacer rings are available so that dimension 'A' may remain constant regardless of the number or size of fingers chosen.

We can also provide half boss interlocking fingers to reduce the overall height. However, this option should only be used when absolutely necessary because of reduced strength.

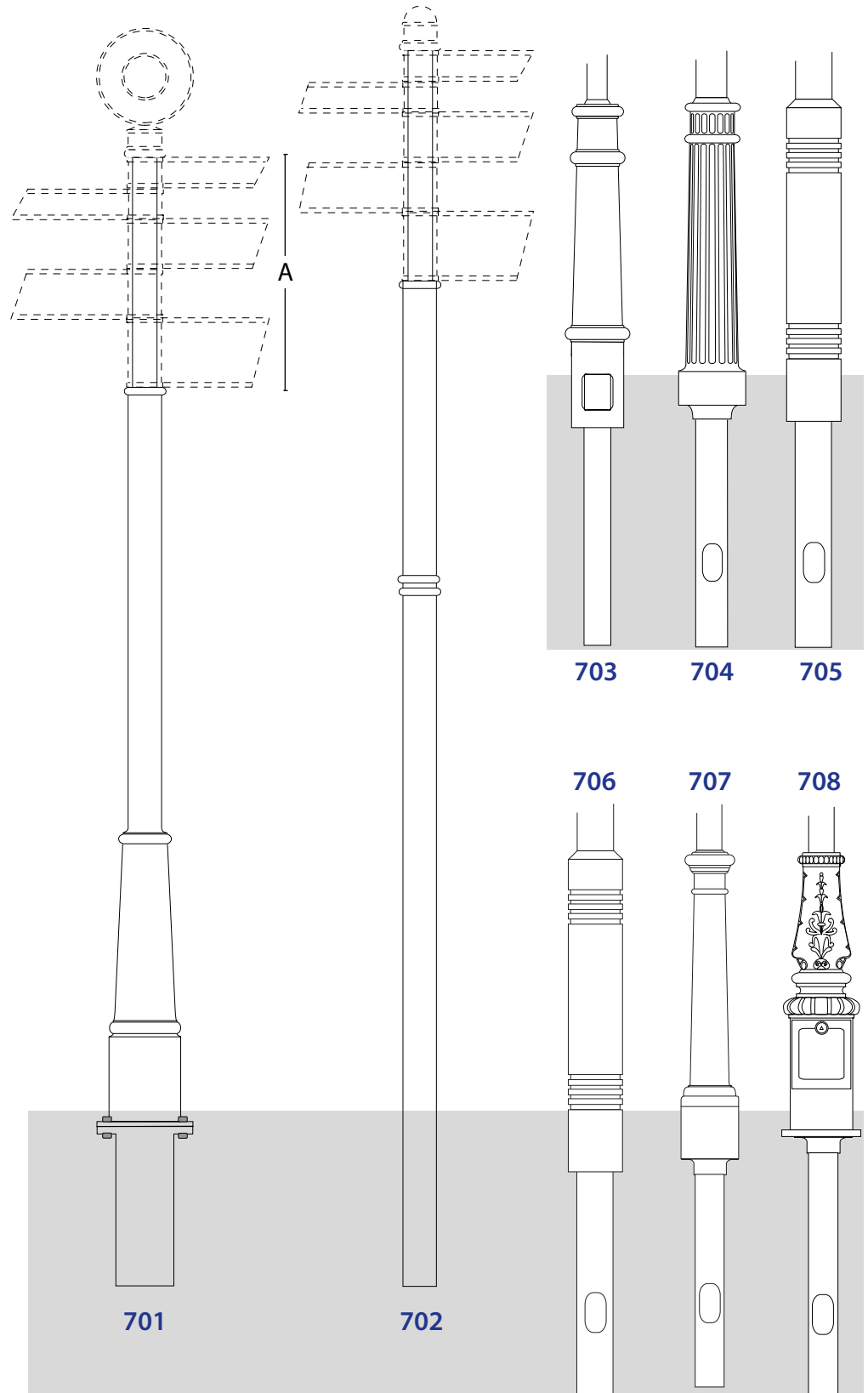

# Information Signs

## FINGER POSTS

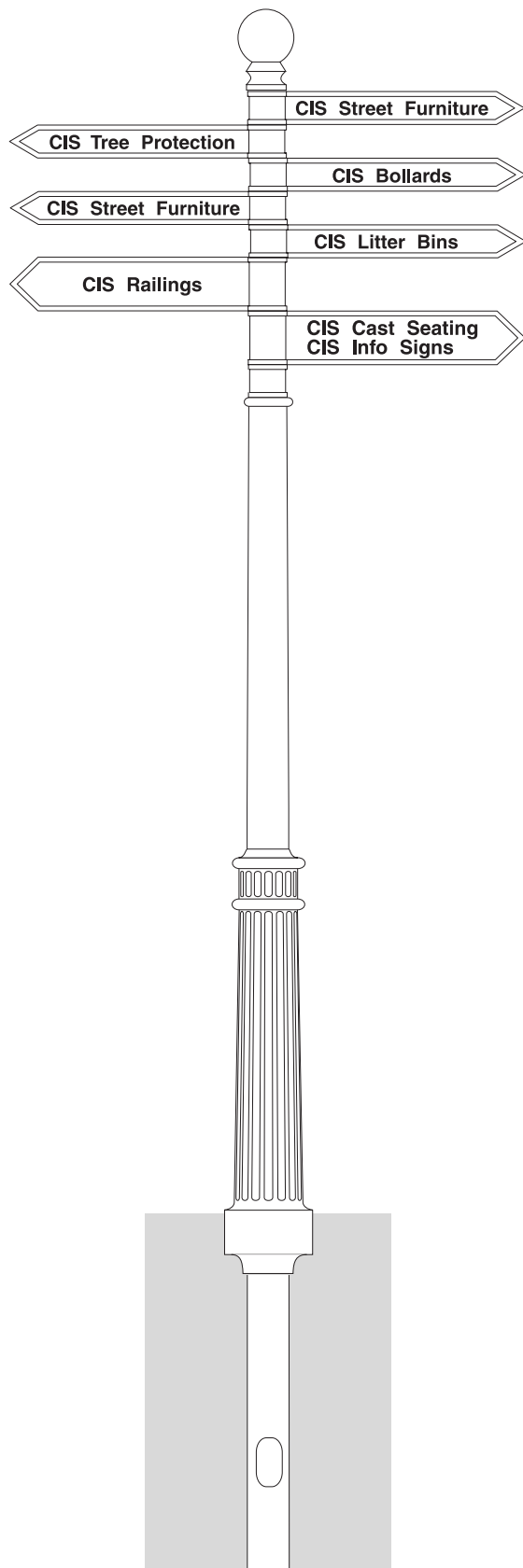

# Information Signs

## FINGERS

Cast aluminium fingers are in three sizes to take one, two or three lines of text. Any combination may be used together. Our sales staff can help decide the required finger based on length and number of words/symbols etc.

Finger arms can be manufactured with split bosses to facilitate clamping to existing posts of most types.

## SPACERS

Within a scheme it is often desirable to make all columns the same height. To achieve this spacer rings are available so column height remains constant regardless of the number or size of fingers chosen.

Spacer rings are often used on schemes where it may be necessary to add finger arms at a later date.

We recommended that you always use a minimum of two rings per column. These can be placed at the top and base of fingers. If this is done throughout a scheme then in years to come modifications can be made quickly and easily.

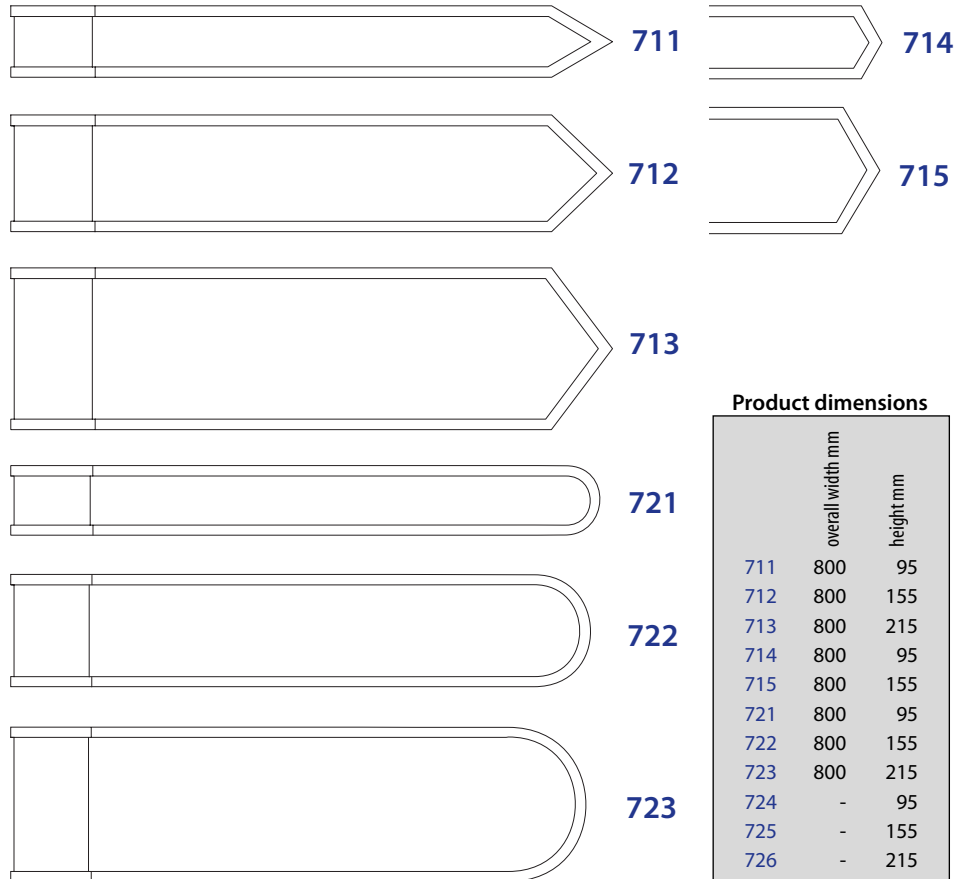

Product dimensions

	overall width mm	height mm
711	800	95
712	800	155
713	800	215
714	800	95
715	800	155
721	800	95
722	800	155
723	800	215
724	-	95
725	-	155
726	-	215



724

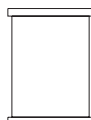

725



726



## FINGER LAYOUT & TYPEFACES

The positioning of text has a great bearing on its appearance. It is worth remembering that the Department of Transport guidelines say that wording should be no smaller than 35mm on traffic related signs. Our sales office can offer guidance on this if you require.

With many hundreds of typefaces available, choosing one of them can seem daunting. As an aid we have carefully selected four of these as standard for use on finger posts and notice boards. The capital height of each style is approximately 44mm.

We supply draft layouts of the fingers for approval, before casting.

## SPECIAL SIGNS

The Rother market sign and flower columns were designed in conjunction with Stratford Upon Avon District Council. A sign like this with simple text modifications (as shown) could be used at any cattle market, for instance.

# Information Signs

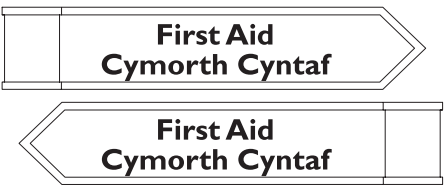

A Text fully centred, both sides of fingers

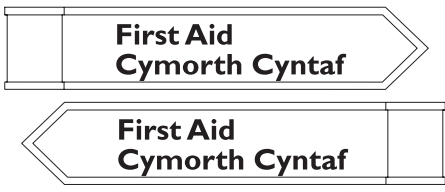

B Block centred on finger  
Text ranged left both sides

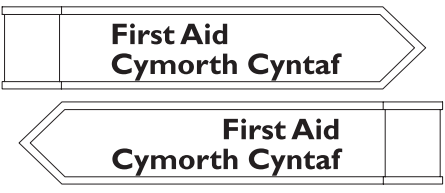

C Block centred on finger  
Text ranged left or right

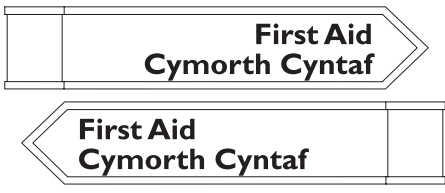

D Text ranged to end, both sides of finger

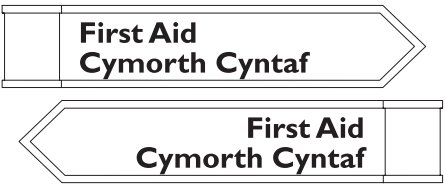

E Text ranged to boss, both sides of finger

Our four standard typefaces

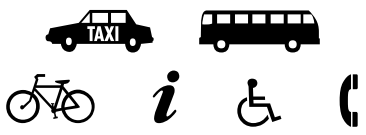

A small selection of many symbols available for use on cast fingers



# Information Signs

## FINIALS

Columns for finger posts and notice boards may be topped by a variety of completely interchangeable shapes and sizes of finial.

731 is an example that has been designed by a customer to convey a regional identity.

Finials 734 to 737 are designed to complement popular styles of vehicle control bollards.

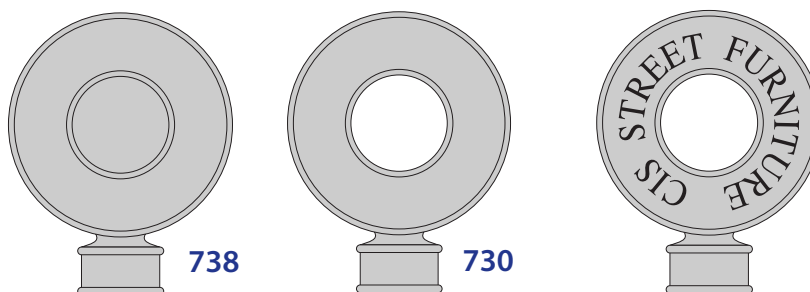

The 730 and 738 finials may be used with or without lettering.

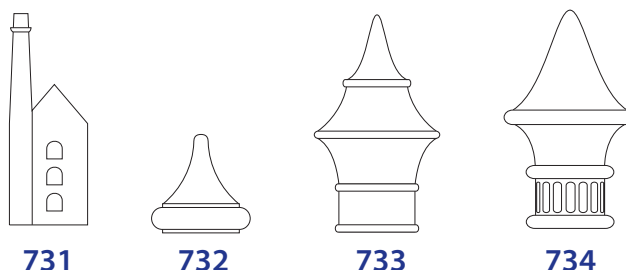

Product dimensions

	max width mm	max height mm
730	300	380
731	110	305
732	135	135
733	170	295
734	180	300
735	160	230
736	115	225
737	115	120
738	300	380

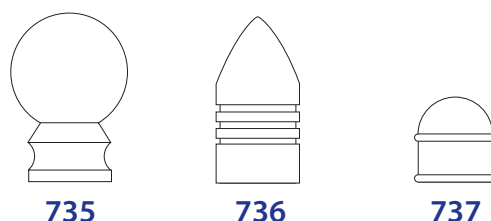

# Information Signs



## SPECIALS



Finger columns formed the basis for a small information plaque for the London borough of Southwark. A special casting was made to hold plaques around the finger column base. These can be found dotted along the River Thames.



The Redhill town sign was particularly challenging. The design blends pure signage with fabrication work to produce these gateway features. These signs can be found at all entrances to the town centre.

Signage is a feature customised within many schemes. CIS Street Furniture is able to work with clients in order to create many stunning designs, from simple hanging baskets to major town centre signage.



## STREET NAMES

ROMAN ROAD E2



These traditional cast street nameplates are manufactured from cast aluminium (to give more definition) and are much more durable than pressed steel and other alternative materials. With simple maintenance and the occasional re-paint they will last a lifetime.

Signs can be wall mounted, post mounted or guardrail mounted. Space can be provided for sponsorship or council logos and crests.

# Information Signs

## HANGING BASKET COLUMNS

A brilliant way of adding colour to town centres, esplanades etc. is the use of hanging basket columns. A few of these dotted around will liven up any town centre.

The range of columns available matches those used as finger columns, therefore it is possible to use a bollard base to suit other items within a scheme.

Standard brackets are manufactured from ductile iron or steel and can be especially designed if required.

Columns are available with or without self-watering systems. A choice of finial is also offered to suit.

All columns (except 701) are of a composite design and have steel on their core materials. Embellishments are only added as a decorative feature and are not structural.



7005

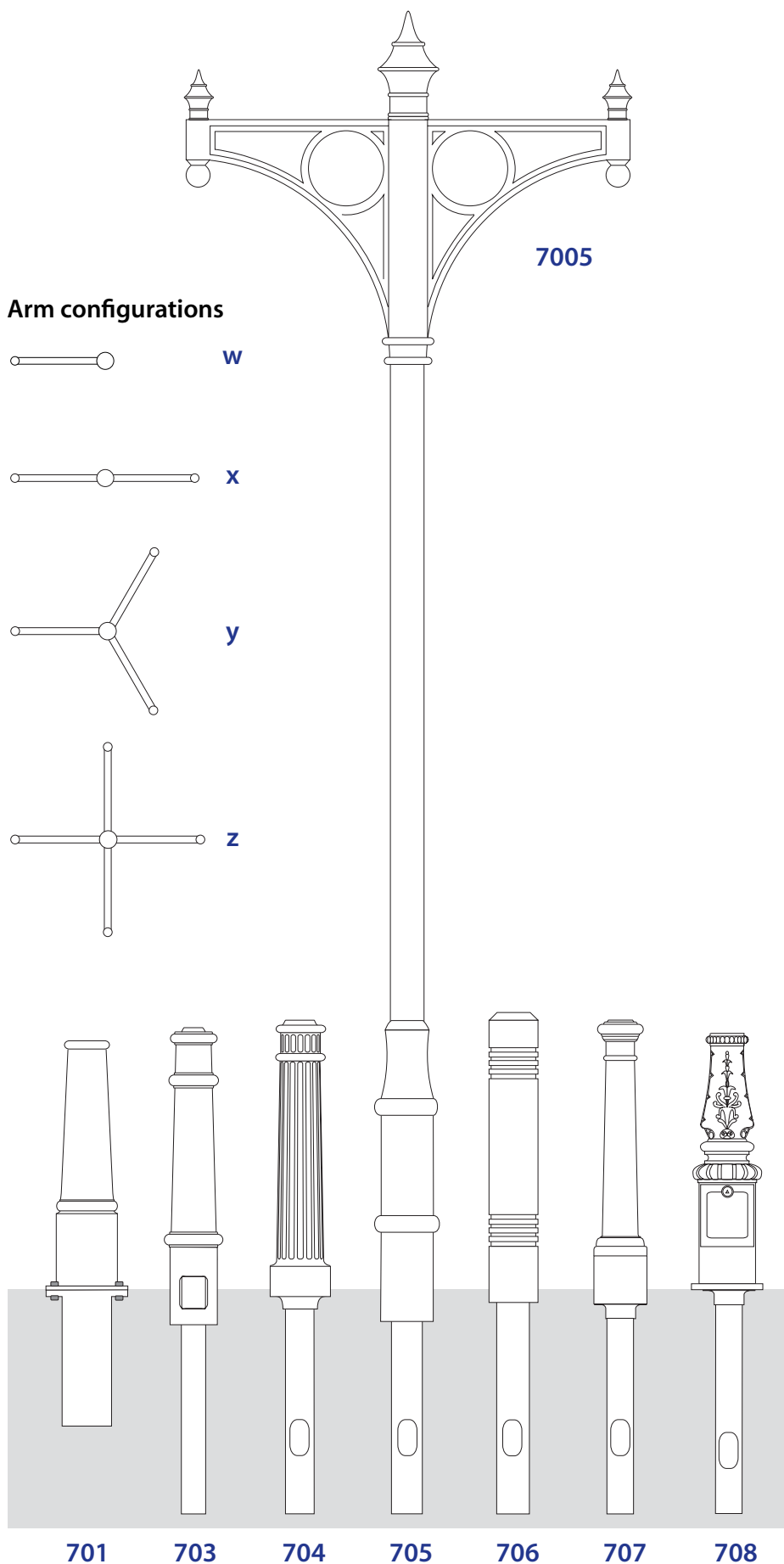

# Information Signs

## HANGING BASKET COLUMNS

Hanging bracket outreach brackets 7003 - 7005 are equally suitable for wall mounting to add to your design versatility.

For ordering codes please use the column reference number followed by the finial, bracket and arm configuration numbers e.g. 701/734/7001/x.

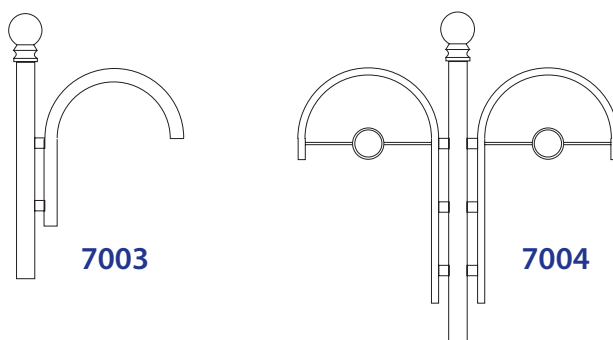
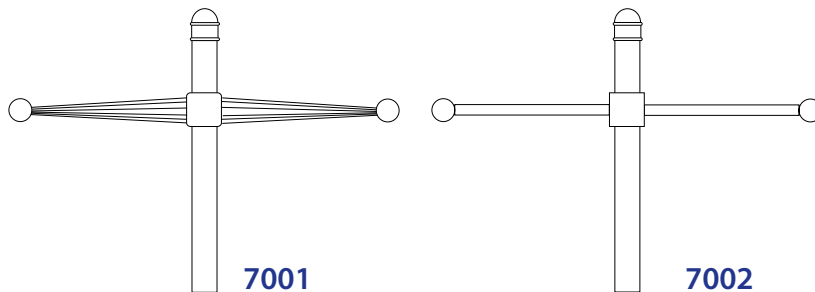

# Information Signs

## INFORMATION BOARDS

As permanent features designed to attract attention, notice boards should be easy to locate but not clash with their surroundings.

The 751 noticeboard can be made single or double sided and includes a customised header board. Wording, logos and crests can be added to personalise boards to your design. A single sheet hinged opening door is supplied for quick and easy poster maintenance. Locks are provided with common keys for easy access.

Design type 752 has two hinged opening doors giving a larger viewing area. It also shares the same features as the 751 design.

Type 753 offers all the benefits of 751 but with a simplified header board.

All boards are supplied as standard with a tapping rail. This assists the visually impaired in finding their way around such potentially dangerous obstacles.

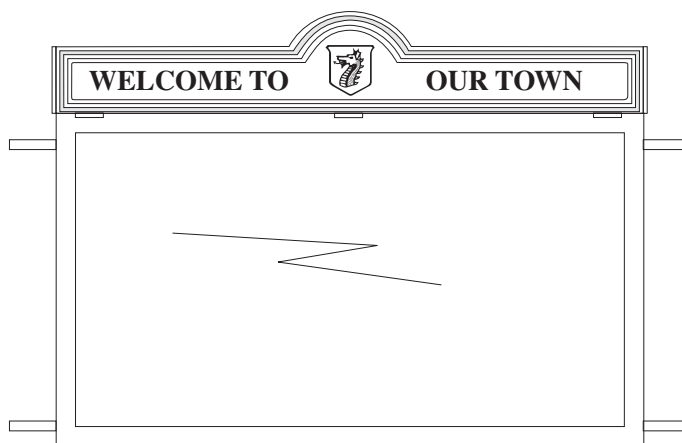

751

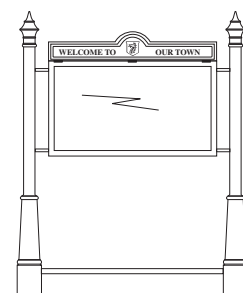

with 701 & 733

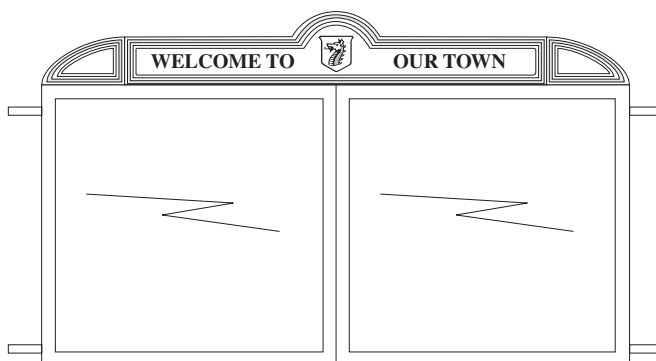

752

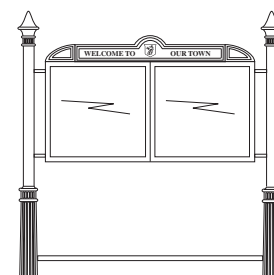

with 704 & 734

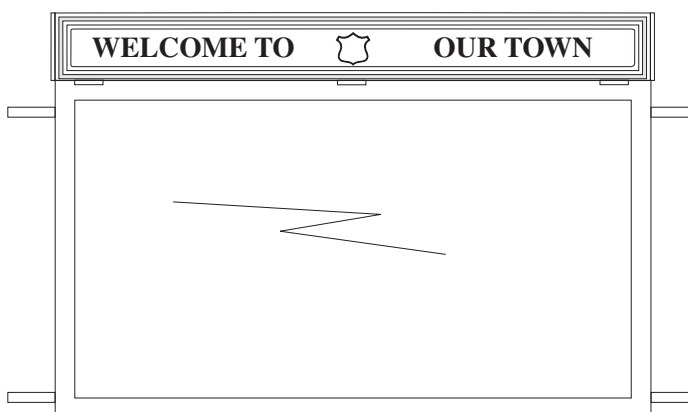

753

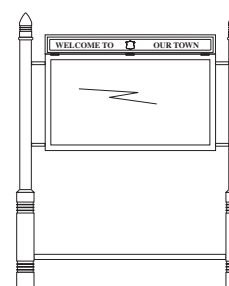

with 706 & 736

# Information Signs

## INFORMATION BOARDS



Choices of columns are available to suit and can be viewed on page 7.2 of this section of the catalogue. A selection of optional finials are available and are shown on page 7.6.

All boards can be designed to accommodate internal illumination. Our sales office can offer advice regarding design and price.

Board types 761 and 762 are of a somewhat different design to those preceding. Their simple but elegant lines would be more suited to a modern environment than those shown on the previous page.

The 770 notice board is fully cast and can incorporate text, logos, crests, raised maps or tourist information. There are no doors, as this board is designed to be fully painted with any raised areas (i.e. crests, lettering etc.) finished in a contrasting colour.

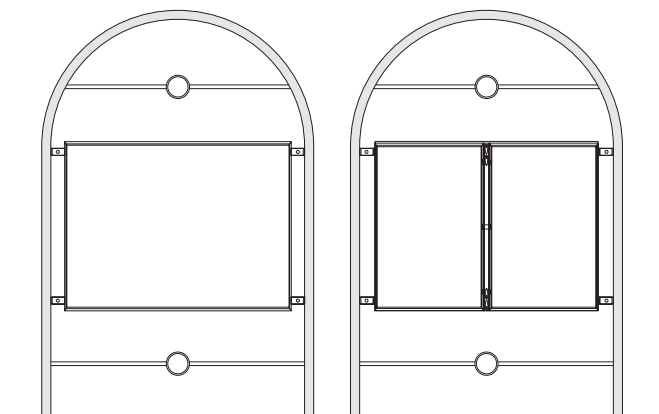

761

762

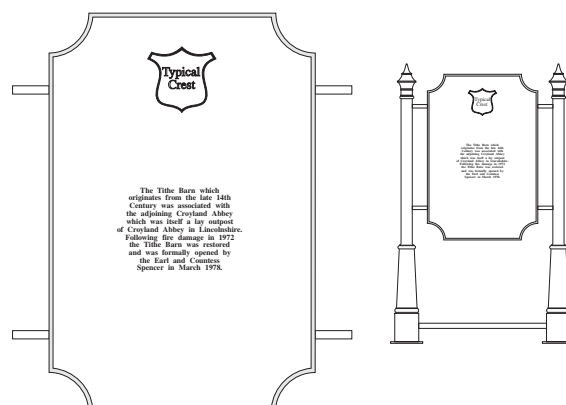

770



Certificate Number FM 32898

**CIS Street Furniture**  
**Albany Court**  
**Blenheim Road**  
**Airfield Industrial Estate**  
**ASHBOURNE**  
**Derbyshire**  
**DE6 1HA**

**T: 01335 300234**

**F: 01335 300353**

**E: sales@cis-streetfurniture.co.uk**

**W: www.cis-streetfurniture.co.uk**

#### **Fixings**

All fixing details and foundations are purely advisory. Ground and service conditions may vary locally. We advise you to consult a structural engineer if in any doubt.

In line with our policy of continual improvement, we reserve the right to change, without prior notice, any of the data contained in this publication. The information given is believed to be correct at the time of printing.

CIS Street Furniture is a trading name of DKT Group Ltd. All rights reserved. Neither whole nor part of this publication may be copied without the written permission of the publishers. The designs are the property of DKT Group Ltd and may not be reproduced without express permission. © September 2000.